

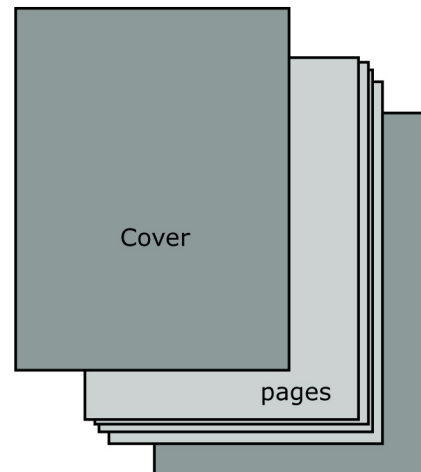

Japanese Four-Hole Bind page 1

This is a really elegant binding with many stitch variations possible. They don't open very flat so soft flexible paper is the best material.

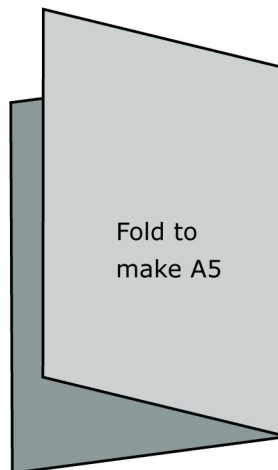
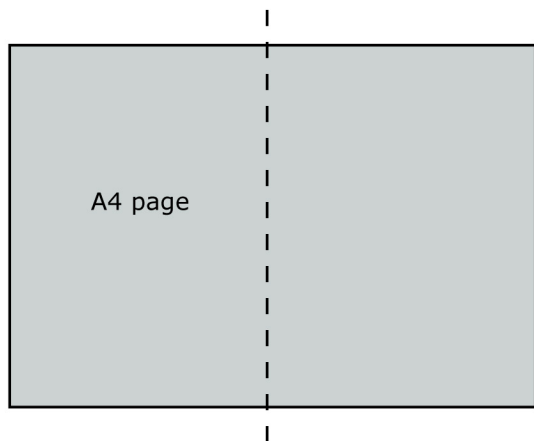

1. Cut a stack of pages, in this example there are 10 pages of A4 (210mm x 297mm) folded in-half to make an A5 book. The covers are the same size but on slightly heavier paper also folded. Japanese papers sold in art shops are ideal since they are very flexible. Fold the pages back on themselves so the folded edge is outermost.

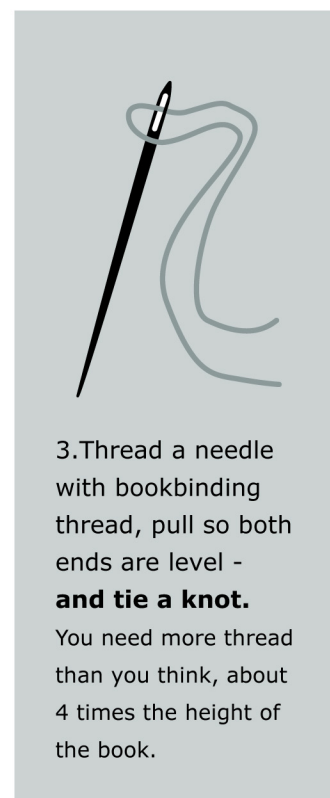
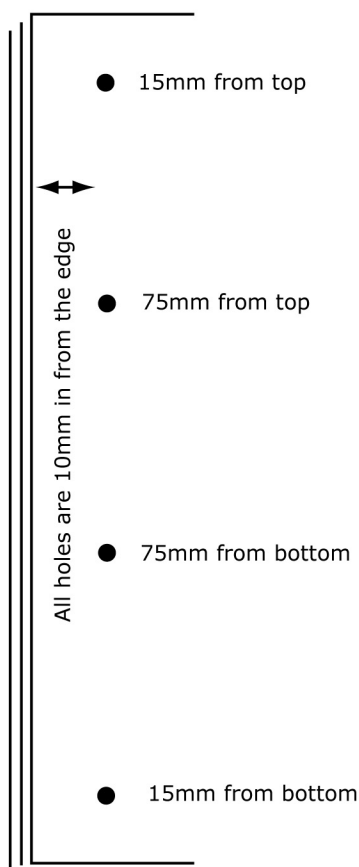
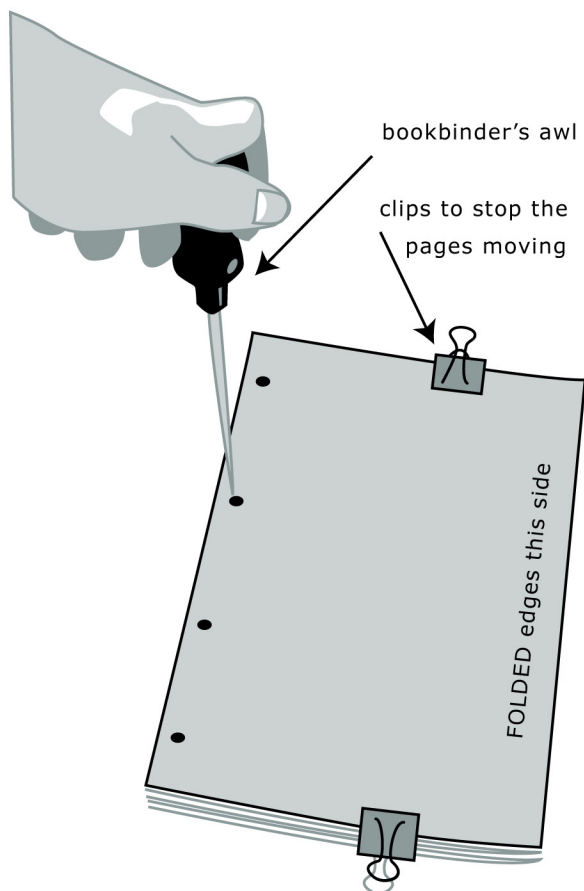

2. Cut Use clips to hold the pages together and mark 4 holes. Using a bookbinder's awl punch 4 holes. The holes are 10mm in from the left edge. 15mm from top and bottom and then 75mm from top and bottom.

3. Thread a needle with bookbinding thread, pull so both ends are level - **and tie a knot.** You need more thread than you think, about 4 times the height of the book.



5. Diagrams for the sewing

4. Starting at one of the middle holes - lift open two or three pages and insert the needle under these sheets and out through a central hole. The knot will pull-tight, now bring the needle around the spine and back into the same hole and out. Pull tight. This starts the bind
Now follow the diagrams to complete it.

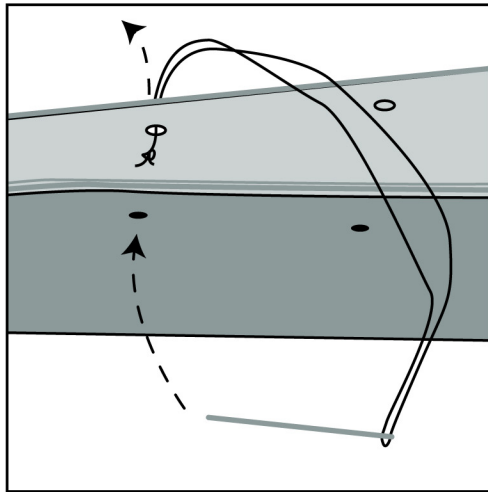

6. Finishing off. Tie a knot by threading the needle under and over the stitches. Then push the needle back down through the hole and cut off the thread.

